

LM4915 Boomer® Audio Power Amplifier Series

Pseudo-Differential Mono Headphone Amplifier with Fixed 6dB Gain

General Description

The LM4915 is a pseudo-differential audio power amplifier primarily designed for demanding applications in mobile phones and other portable audio device applications with mono headphones. It is capable of delivering 90 milliwatts of continuous average power to a 32Ω BTL load with less than 1% distortion (THD+N) from a 3V_{DC} power supply.

Boomer audio power amplifiers were designed specifically to provide high quality output power with a minimal amount of external components. The LM4915 does not require output coupling capacitors or bootstrap capacitors, and therefore is ideally suited for mobile phone and other low voltage applications where minimal power consumption is a primary requirement.

The LM4915 features a low-power consumption shutdown mode. To facilitate this, Shutdown may be enabled by driving the shutdown pin low. Additionally, the LM4915 features an internal thermal shutdown protection mechanism.

The LM4915 contains advanced pop & click circuitry which virtually eliminates noises which would otherwise occur during turn-on and turn-off transitions.

The LM4915 has an internally fixed gain of 6dB.

Key Specifications

- Improved PSRR at 217Hz and 1kHz 75dB (typ)
- Power Output at 5.0V & 1% THD into 32Ω 280mW (typ)
- Power Output at 3.0V & 1% THD into 32Ω 90mW (typ)
- Output Noise, A-weighted 20μV (typ)

Features

- Pseudo-differential amplification
- Internal gain-setting resistors
- Available in space-saving LLP package
- Ultra low current shutdown mode
- Can drive capacitive loads up to 500pF
- Improved pop & click circuitry virtually eliminates noises during turn-on and turn-off transitions
- 2.2 - 5.5V operation
- No output coupling capacitors, snubber networks, bootstrap capacitors or gain-setting resistors required
- Ultra low noise

Applications

- Mobile phones
- PDAs
- Portable electronics devices

Typical Application

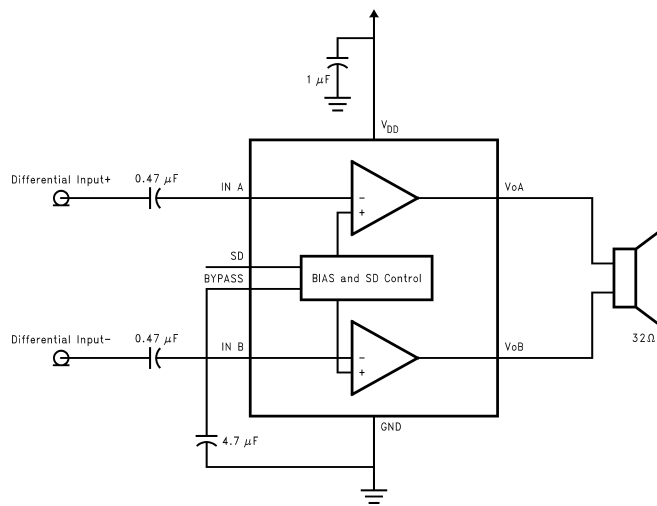
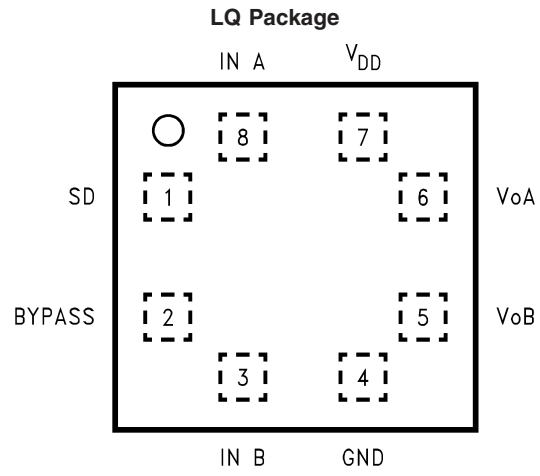

FIGURE 1. Typical Audio Amplifier Application Circuit

Connection Diagrams



200482B5

Top View
Order Number LM4915LQ
See NS Package Number LQB08A

8 Pin LQ Marking

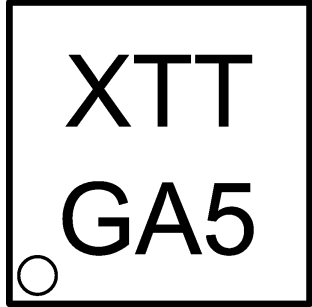

200482E7

X - Date Code
TT - Die Traceability
G - Boomer
A5 - LM4915LQ

Absolute Maximum Ratings (Note 2)

If Military/Aerospace specified devices are required, please contact the National Semiconductor Sales Office/Distributors for availability and specifications.

Supply Voltage	6.0V
Storage Temperature	-65°C to +150°C
Input Voltage	-0.3V to $V_{DD} + 0.3V$
Power Dissipation (Note 3)	Internally Limited
ESD Susceptibility (Note 4)	2000V
ESD Susceptibility (Note 5)	200V

Junction Temperature	150°C
Thermal Resistance	
θ_{JC} (LQ)	57°C/W
θ_{JA} (LQ)	140°C/W

Operating Ratings

Temperature Range	$T_{MIN} \leq T_A \leq T_{MAX}$	$-40^\circ\text{C} \leq T_A \leq +85^\circ\text{C}$
Supply Voltage (V_{DD})		$2.2V \leq V_{CC} \leq 5.5V$

Electrical Characteristics $V_{DD} = 5V$ (Notes 1, 2, 8)

The following specifications apply for $V_{DD} = 5V$, $R_L = 16\Omega$ unless otherwise specified. Limits apply to $T_A = 25^\circ\text{C}$.

Symbol	Parameter	Conditions	LM4915		Units (Limits)
			Typ (Note 6)	Limit (Note 7)	
I_{DD}	Quiescent Power Supply Current	$V_{IN} = 0V, I_O = 0A$	2	3.5	mA (max)
I_{SD}	Shutdown Current	$V_{SHUTDOWN} = GND$	0.1	Note 9	μA (max)
V_{SDIH}	Shutdown Voltage Input High		1.8		V
V_{SDIL}	Shutdown Voltage Input Low		0.4		V
P_O	Output Power	THD = 1% (max); f = 1kHz $R_L = 16$ $R_L = 32$	400 280	375 250	mW
V_{NO}	Output Noise Voltage	BW = 20Hz to 20kHz, A-weighted	20		μV
PSRR	Power Supply Rejection Ratio	$V_{RIPPLE} = 200mV$ sine p-p	75		dB
V_{OS}	Output Offset Voltage	$V_{IN} = 0V$	2	20	mV (max)

Electrical Characteristics $V_{DD} = 3.0V$ (Notes 1, 2, 8)

The following specifications apply for $V_{DD} = 3.0V$, $R_L = 16\Omega$ unless otherwise specified. Limits apply to $T_A = 25^\circ\text{C}$.

Symbol	Parameter	Conditions	LM4915		Units (Limits)
			Typ (Note 6)	Limit (Note 7)	
I_{DD}	Quiescent Power Supply Current	$V_{IN} = 0V, I_O = 0A$	1.5	2.5	mA (max)
I_{SD}	Shutdown Current	$V_{SHUTDOWN} = GND$	0.1	Note 9	μA (max)
V_{SDIH}	Shutdown Voltage Input High		1.8		V
V_{SDIL}	Shutdown Voltage Input Low		0.4		V
P_O	Output Power	THD = 1% (max); f = 1kHz $R_L = 16$ $R_L = 32$	125 90	100 80	mW (min)
V_{NO}	Output Noise Voltage	BW = 20Hz to 20kHz, A-weighted	20		μV
PSRR	Power Supply Rejection Ratio	$V_{RIPPLE} = 200mV$ sine p-p	70		dB
V_{OS}	Output Offset Voltage	$V_{IN} = 0V$	2	20	mV (max)

Note 1: All voltages are measured with respect to the GND pin unless otherwise specified.

Note 2: Absolute Maximum Ratings indicate limits beyond which damage to the device may occur. Operating Ratings indicate conditions for which the device is functional but do not guarantee specific performance limits. Electrical Characteristics state DC and AC electrical specifications under particular test conditions which guarantee specific performance limits. This assumes that the device is within the Operating Ratings. Specifications are not guaranteed for parameters where no limit is given, however, the typical value is a good indication of device performance.

Note 3: The maximum power dissipation must be derated at elevated temperatures and is dictated by T_{JMAX} , θ_{JA} , and the ambient temperature, T_A . The maximum allowable power dissipation is $P_{DMAX} = (T_{JMAX} - T_A) / \theta_{JA}$ or the number given in Absolute Maximum Ratings, whichever is lower. For the LM4915, see power derating curves for more information.

Note 4: Human body model, 100pF discharged through a 1.5k Ω resistor.

Note 5: Machine Model, 220pF-240pF discharged through all pins.

Note 6: Typicals are measured at 25°C and represent the parametric norm.

Note 7: Limits are guaranteed to National's AOQL (Average Outgoing Quality Level).

Note 8: Datasheet min/max specifications are guaranteed by design, test, or statistical analysis.

Electrical Characteristics $V_{DD} = 3.0V$ (Notes 1, 2, 8) (Continued)

Note 9: See I_{SD} distribution values shown in the I_{SD} Distribution curve, $V_{DD} = 5V$ and $V = 3V$, shown in the **Typical Performance Characteristics** section.

External Components Description (Figure 1)

Components		Functional Description
1.	C_B	Bypass pin capacitor that provides half-supply filtering. Refer to the section Proper Selection of External Components for information concerning proper placement and selection of C_B .
2.	C_i	Input coupling capacitor which blocks the DC voltage at the amplifier's input terminals. Also creates a high-pass filter with the internal input resistance R_i . For the LM4915, $R_i = 20k\Omega$, thus creating a high-pass filter $f_c = 1/(2\pi R_i C_i)$. Refer to the section Proper Selection of External Components for an explanation of how to determine the value of C_i .

Typical Performance Characteristics

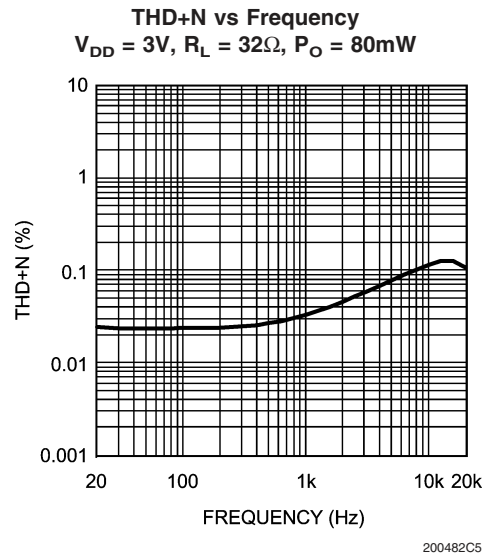
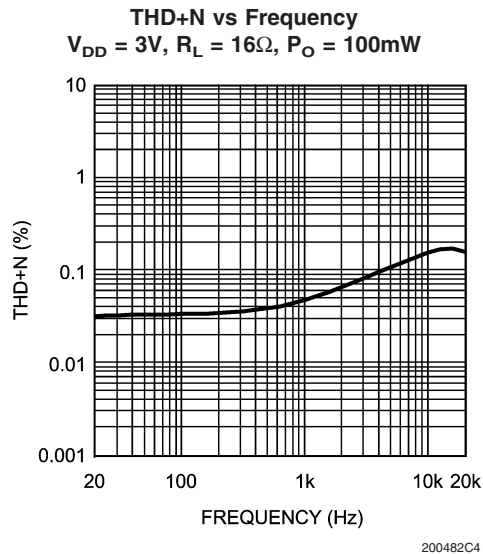
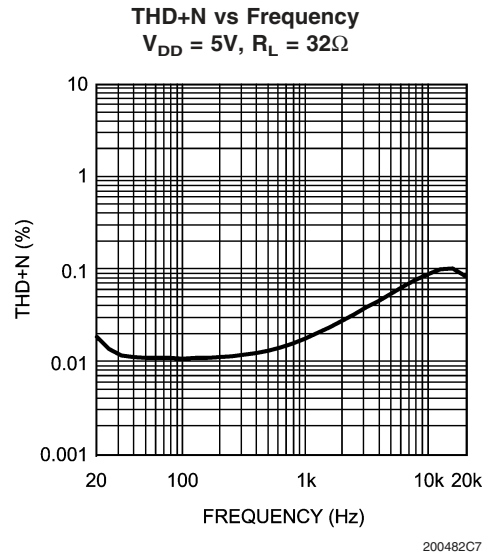
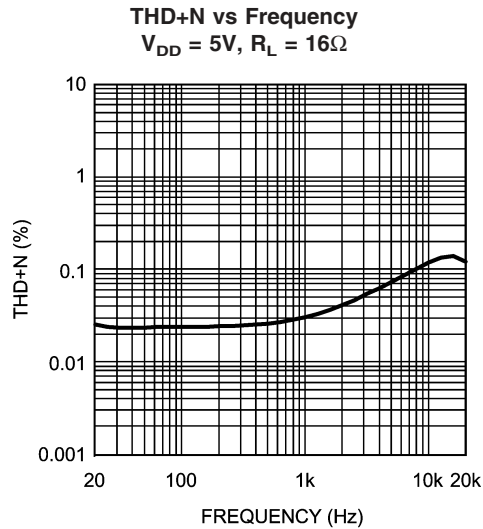

Typical Performance Characteristics (Continued)

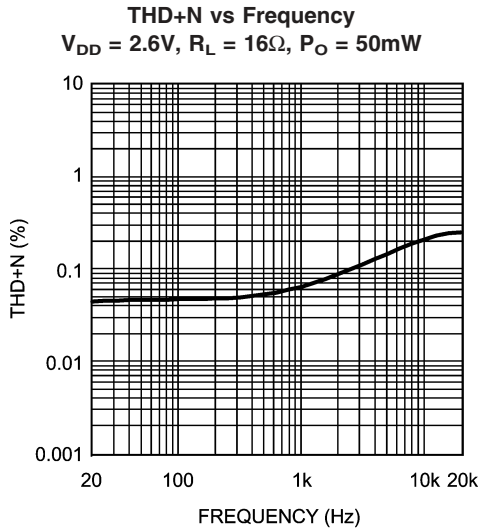

200482C2

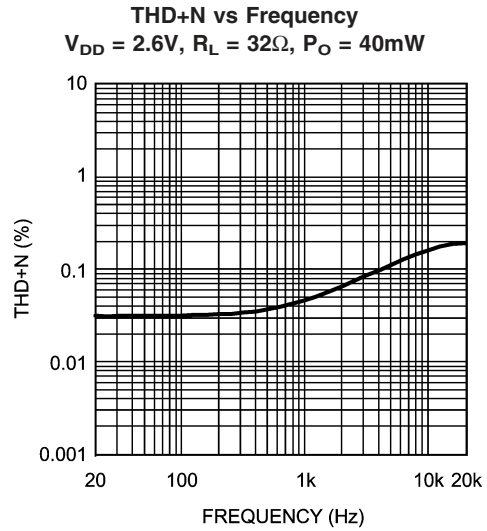

200482C3

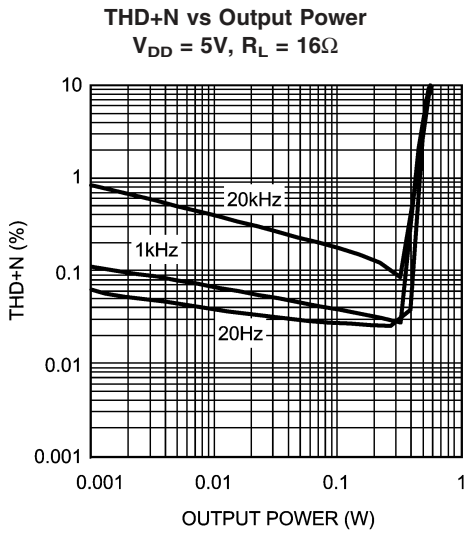

200482D2

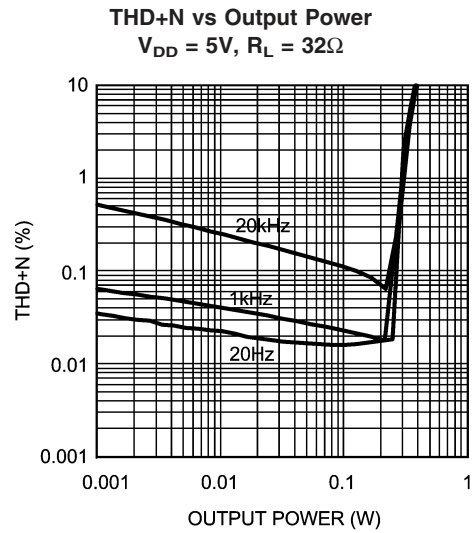

200482D3

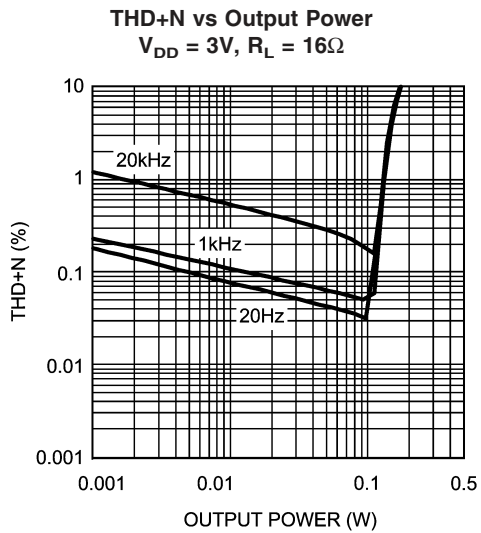

200482D0

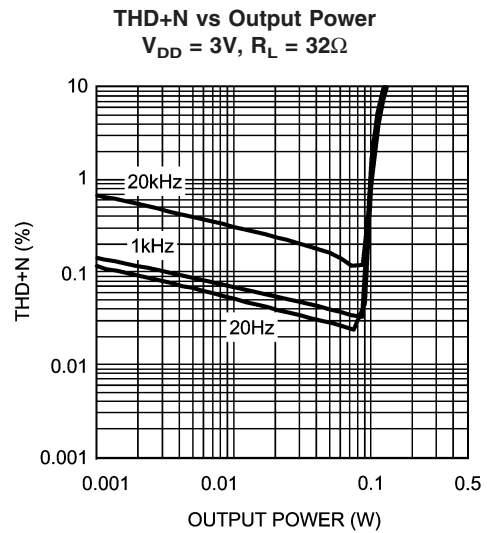

200482D1

Typical Performance Characteristics (Continued)

THD+N vs Output Power
 $V_{DD} = 2.6V, R_L = 16\Omega$

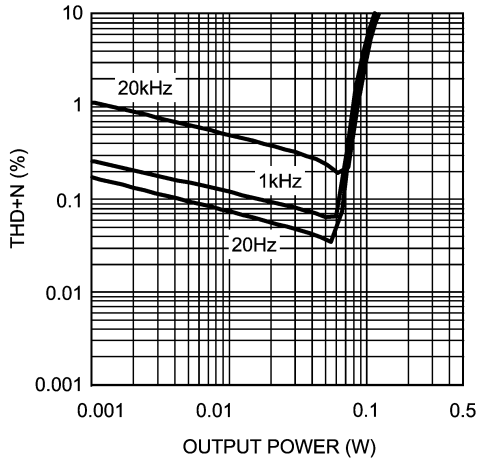

200482C8

THD+N vs Output Power
 $V_{DD} = 2.6V, R_L = 32\Omega$

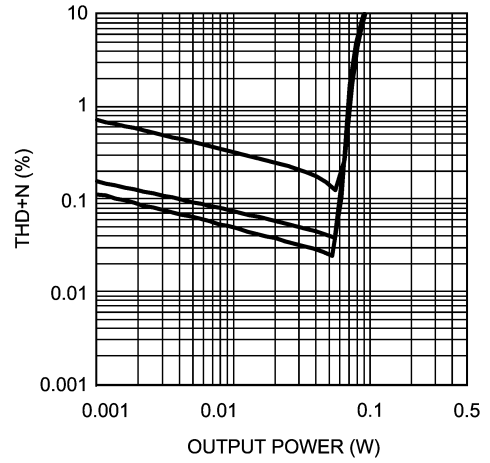

200482C9

PSRR vs Frequency
 $V_{DD} = 5V, R_L = 16\Omega, P_O = 375mW$
 Input 10Ω Terminated

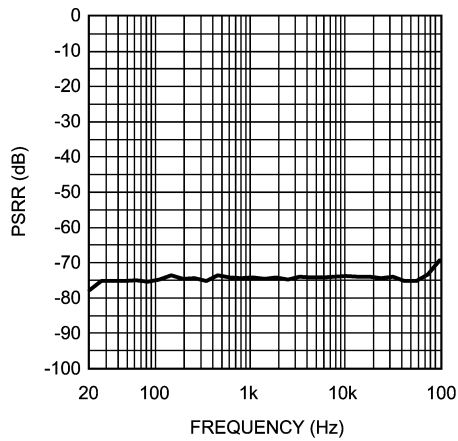

200482C0

PSRR vs Frequency
 $V_{DD} = 5V, R_L = 32\Omega, P_O = 250mW$
 Input 10Ω Terminated

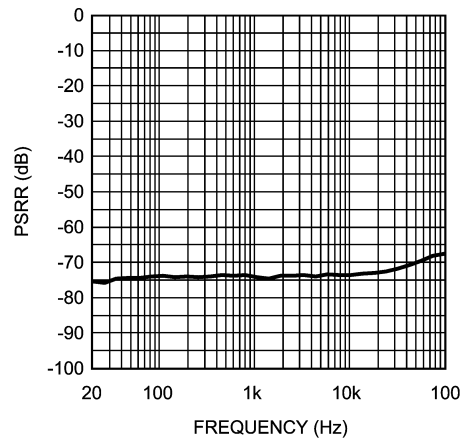

200482C1

PSRR vs Frequency
 $V_{DD} = 3V, R_L = 16\Omega$
 Input 10Ω Terminated

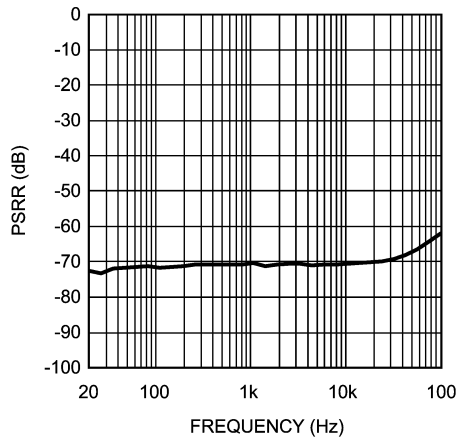

200482B8

PSRR vs Frequency
 $V_{DD} = 3V, R_L = 32\Omega$
 Input 10Ω Terminated

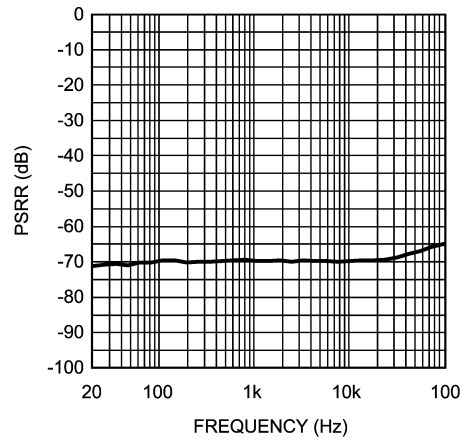

200482B9

Typical Performance Characteristics (Continued)

PSRR vs Frequency
 $V_{DD} = 2.6V$, $R_L = 16\Omega$
 Input 10Ω Terminated

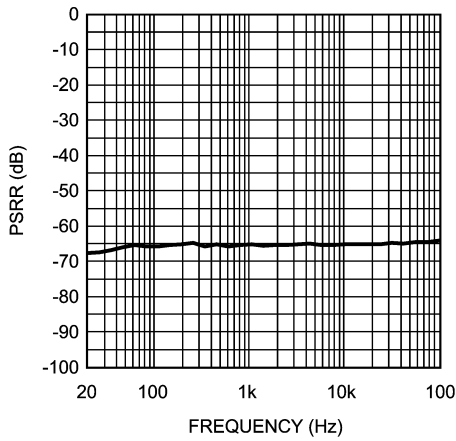

200482B6

PSRR vs Frequency
 $V_{DD} = 2.6V$, $R_L = 32\Omega$
 Input 10Ω Terminated

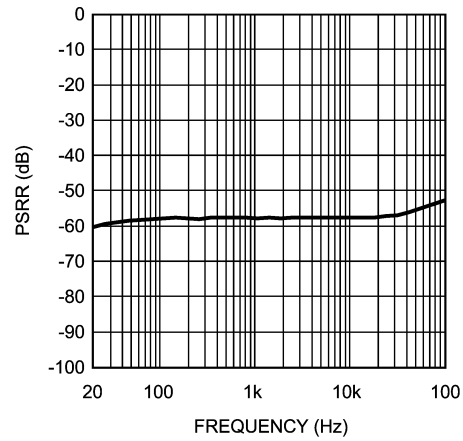

200482B7

Output Power vs Load Resistance
 $V_{DD} = 2.6V$, $R_L = 32\Omega$

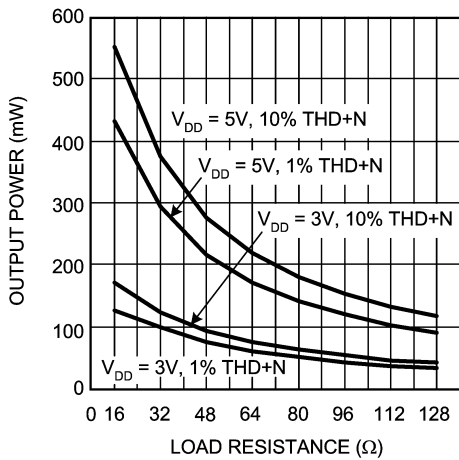

200482D9

Output Power vs Supply Voltage
 $R_L = 16\Omega$

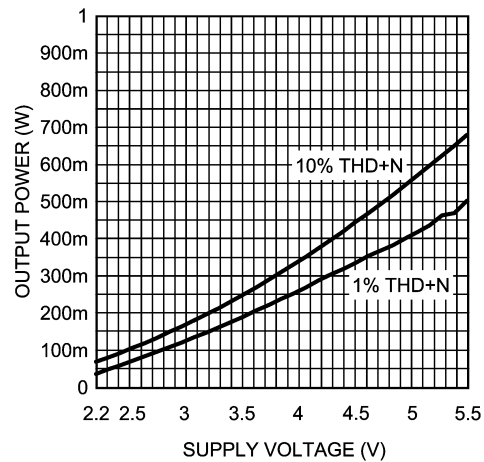

200482E5

Output Power vs Supply Voltage
 $R_L = 32\Omega$

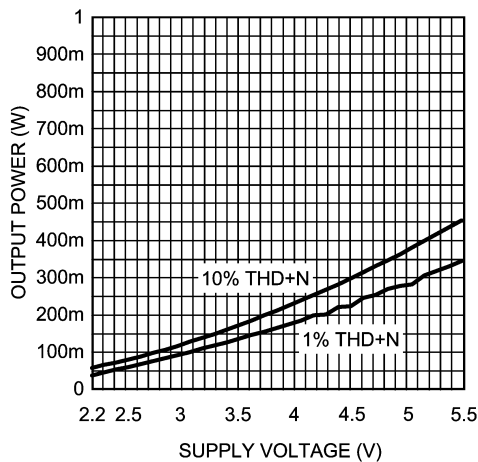

200482E4

Power Dissipation vs Output Power
 $V_{DD} = 5V$

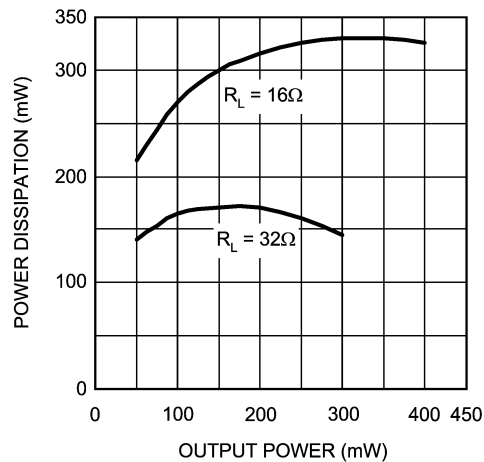

200482E1

Typical Performance Characteristics (Continued)

Power Dissipation vs Output Power
 $V_{DD} = 3V$

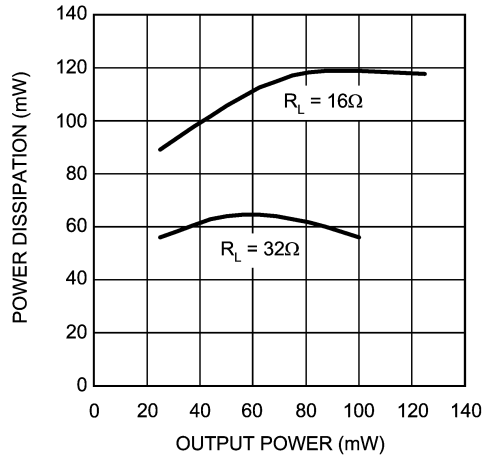

200482E0

Frequency Response vs Input Capacitor Size

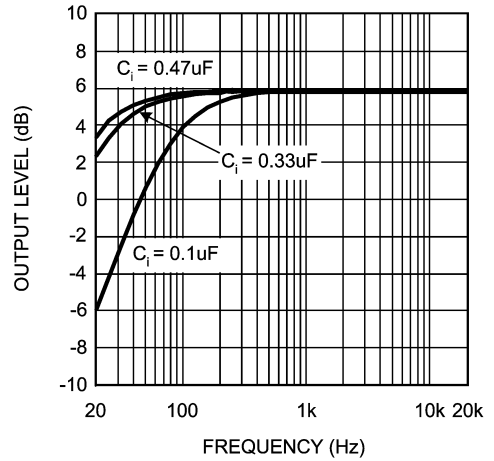

200482E6

Noise Floor

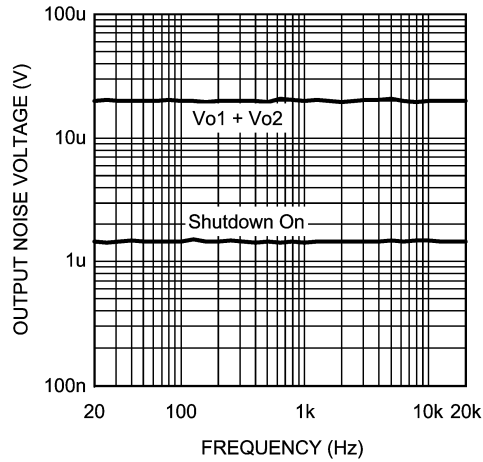

200482D8

Shutdown Hysteresis Voltage
 $V_{DD} = 5V$

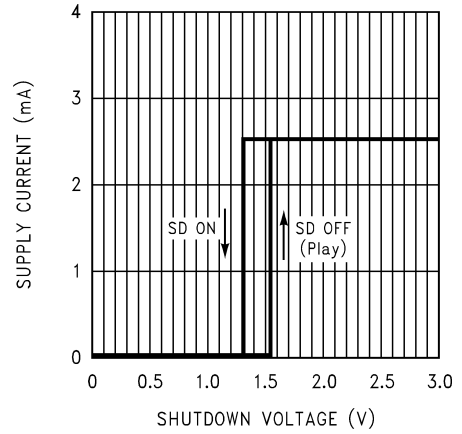

200482E8

Shutdown Hysteresis Voltage
 $V_{DD} = 3V$

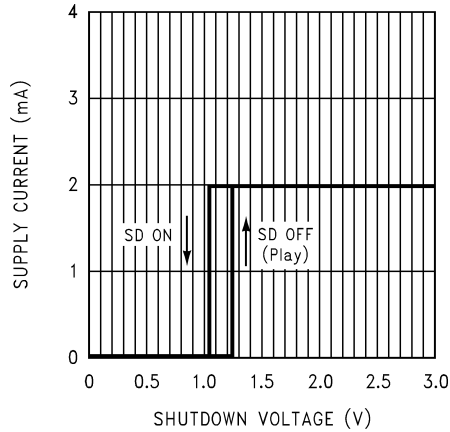

200482E9

I_{SD} Distribution
 $V_{DD} = 5V$

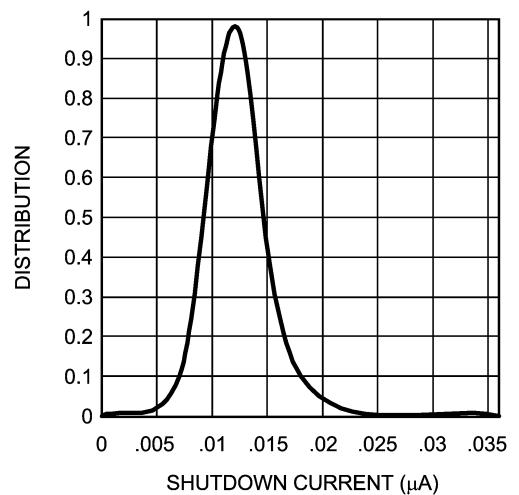

200482F0

Typical Performance Characteristics (Continued)

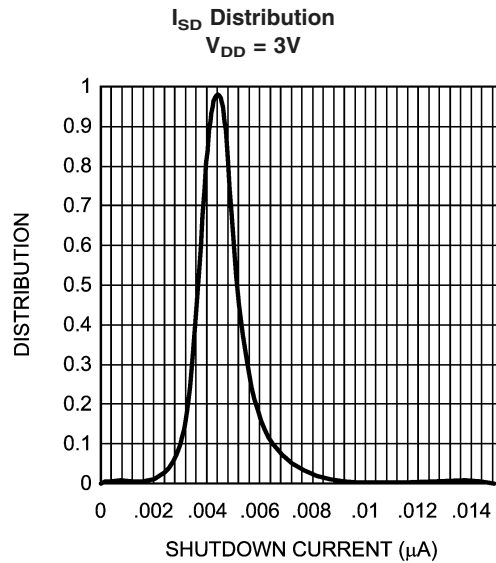

Application Information

DIFFERENTIAL AMPLIFIER EXPLANATION

The LM4915 is a pseudo-differential audio amplifier that features a fixed gain of 6dB. Internally this is accomplished by two separate sets of inverting amplifiers, each set to a gain of 2. The LM4915 features precisely matched internal gain-setting resistors set to $R_i = 20k\Omega$ and $R_f = 40k\Omega$, thus eliminating the need for external resistors and fixing the differential gain at $A_{VD} = 6dB$.

A differential amplifier works in a manner where the difference between the two input signals is amplified. In most applications, this would require input signals that are 180° out of phase with each other. The LM4915 works in a pseudo-differential manner, so DC offset normally cancelled by a fully differential amplifier needs to be blocked by input coupling capacitors for the LM4915 to amplify the difference between the inputs.

The LM4915 provides what is known as a 'bridged mode' output (bridge-tied-load, BTL). This results in output signals at Vo1 and Vo2 that are 180° out of phase with respect to each other. Bridged mode operation is different from the single-ended amplifier configuration that connects the load between the amplifier output and ground. A bridged amplifier design has distinct advantages over the single-ended configuration: it provides differential drive to the load, thus doubling maximum possible output swing for a specific supply voltage. Four times the output power is possible compared with a single-ended amplifier under the same conditions.

This increase in attainable output power assumes that the amplifier is not current limited or clipped. A bridged configuration, such as the one used in the LM4915, also creates a second advantage over single-ended amplifiers. Since the differential outputs, Vo1 and Vo2, are biased at half-supply, no net DC voltage exists across the load. BTL configuration eliminates the output coupling capacitor required in single-supply, single-ended amplifier configurations. If an output coupling capacitor is not used in a single-ended output con-

figuration, the half-supply bias across the load would result in both increased internal IC power dissipation as well as permanent loudspeaker damage.

POWER DISSIPATION

Power dissipation is a major concern when designing a successful amplifier, whether the amplifier is bridged or single-ended. Equation 1 states the maximum power dissipation point for a single-ended amplifier operating at a given supply voltage and driving a specified output load.

$$P_{DMAX} = (V_{DD})^2 / (2\pi^2 R_L) \quad \text{Single-Ended} \quad (1)$$

However, a direct consequence of the increased power delivered to the load by a bridge amplifier is an increase in internal power dissipation versus a single-ended amplifier operating at the same conditions.

$$P_{DMAX} = 4(V_{DD})^2 / (2\pi^2 R_L) \quad \text{Bridge Mode} \quad (2)$$

Since the LM4915 has bridged outputs, the maximum internal power dissipation is 4 times that of a single-ended amplifier.

Even with this substantial increase in power dissipation, the LM4915 does not require additional heatsinking under most operating conditions and output loading. From Equation 2, assuming a 5V power supply and an 16Ω load, the maximum power dissipation point is 316mW. The maximum power dissipation point obtained from Equation 2 must not be greater than the power dissipation results from Equation 3:

$$P_{DMAX} = (T_{JMAX} - T_A) / \theta_{JA} \quad (3)$$

The LM4915's θ_{JA} in an LQB08A package is 140°C/W. Depending on the ambient temperature, T_A , of the system surroundings, Equation 3 can be used to find the maximum internal power dissipation supported by the IC packaging. If the result of Equation 2 is greater than that of Equation 3,

Application Information (Continued)

then either the supply voltage must be decreased, the load impedance increased, the ambient temperature reduced, or the θ_{JA} reduced with heatsinking. In many cases, larger traces near the output, V_{DD} , and GND pins can be used to lower the θ_{JA} . The larger areas of copper provide a form of heatsinking allowing higher power dissipation. For the typical application of a 5V power supply, with a 16 Ω load power dissipation is not an issue. Recall that internal power dissipation is a function of output power. If typical operation is not around the maximum power dissipation point, the LM4915 can operate at higher ambient temperatures. Refer to the **Typical Performance Characteristics** curves for power dissipation information.

POWER SUPPLY BYPASSING

As with any power amplifier, proper supply bypassing is critical for low noise performance and high power supply rejection ratio (PSRR). The capacitor location on both the bypass and power supply pins should be as close to the device as possible. A larger half-supply bypass capacitor improves PSRR because it increases half-supply stability.

Typical applications employ a 5V regulator with 10 μ F and 0.1 μ F bypass capacitors that increase supply stability. This, however, does not eliminate the need for bypassing the supply nodes of the LM4915. A 1 μ F capacitor is recommended for C_S . A 4.7 μ F capacitor is recommended for C_B . This value coupled with small input capacitors (0.1 μ F to 0.47 μ F) gives virtually zero click and pop with outstanding PSRR performance.

MICRO POWER SHUTDOWN

The voltage applied to the SHUTDOWN pin controls the LM4915's shutdown function. Activate micro-power shutdown by applying a logic-low voltage to the SHUTDOWN pin. When active, the LM4915's micro-power shutdown feature turns off the amplifier's bias circuitry, reducing the supply current. The trigger point is 0.4V for a logic-low level, and 1.8V for a logic-high level. The low 0.1 μ A (typ) shutdown current is achieved by applying a voltage that is as near as ground as possible to the SHUTDOWN pin. A voltage that is higher than ground may increase the shutdown current. There are a few ways to control the micro-power shutdown. These include using a single-pole, single-throw switch, a microprocessor, or a microcontroller. When using a switch, connect an external 100k Ω pull-up resistor between the SHUTDOWN pin and V_{DD} . Connect the switch between the SHUTDOWN pin and ground. Select normal amplifier operation by opening the switch. Closing the switch connects the SHUTDOWN pin to ground, activating micro-power shutdown.

The switch and resistor guarantee that the SHUTDOWN pin will not float. This prevents unwanted state changes. In a system with a microprocessor or microcontroller, use a digital output to apply the control voltage to the SHUTDOWN pin. Driving the SHUTDOWN pin with active circuitry eliminates the pull-up resistor.

PROPER SELECTION OF EXTERNAL COMPONENTS

Proper selection of external components in applications using integrated power amplifiers is critical to optimize device and system performance. While the LM4915 is tolerant of external component combinations, and requires minimal external components, consideration to component values must be used to maximize overall system quality.

The input coupling capacitor, C_i , forms a first order high pass filter which limits low frequency response given by $f_c = 1/(2\pi R_i C_i)$. R_i is internally set to 20k Ω . This value should be chosen based on needed frequency response for a few distinct reasons.

Selection of Input Capacitor Size

Large input capacitors are both expensive and space hungry for portable designs. Clearly, a certain sized capacitor is needed to couple in low frequencies without severe attenuation. But in many cases the speakers used in portable systems, whether internal or external, have little ability to reproduce signals below 100Hz to 150Hz. Thus, using a large input capacitor may not increase actual system performance.

In addition to system cost and size, click and pop performance is affected by the size of the input coupling capacitor, C_i . A larger input coupling capacitor requires more charge to reach its quiescent DC voltage (nominally 1/2 V_{DD}). This charge comes from the output via the feedback and is apt to create pops upon device enable. Thus, by minimizing the capacitor size based on necessary low frequency response, turn-on pops can be minimized.

Besides minimizing the input capacitor size, careful consideration should be paid to the bypass capacitor value. Bypass capacitor, C_B , is the most critical component to minimize turn-on pops since it determines how fast the LM4915 turns on. The slower the LM4915's outputs ramp to their quiescent DC voltage (nominally 1/2 V_{DD}), the smaller the turn-on pop. Choosing C_B equal to 4.7 μ F along with a small value of C_i (in the range of 0.1 μ F to 0.47 μ F), should produce a virtually clickless and popless shutdown function. While the device will function properly, (no oscillations or motorboating), with C_B equal to 1.0 μ F, the device will be much more susceptible to turn-on clicks and pops. Thus, a value of C_B equal to 4.7 μ F is recommended in all but the most cost sensitive designs.

Physical Dimensions inches (millimeters) unless otherwise noted

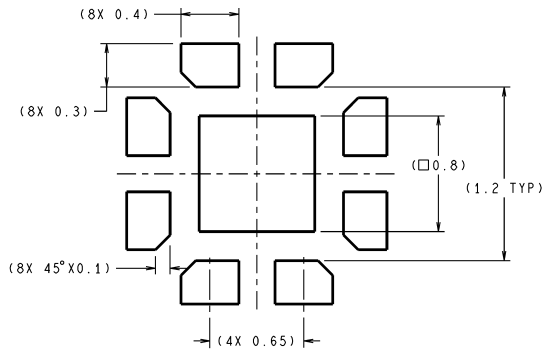

DIMENSIONS ARE IN MILLIMETERS

RECOMMENDED LAND PATTERN
1:1 RATIO WITH PKG SOLDER PADS

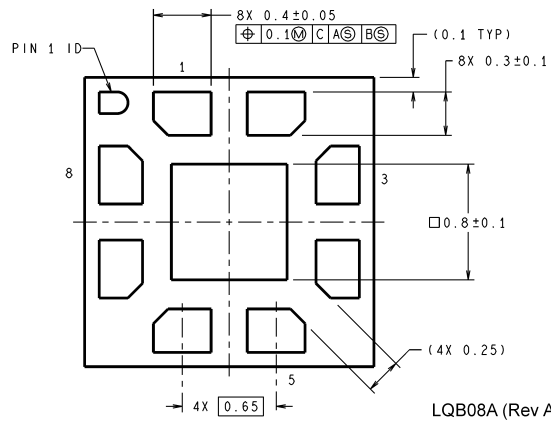
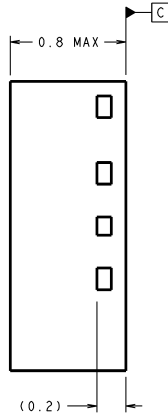
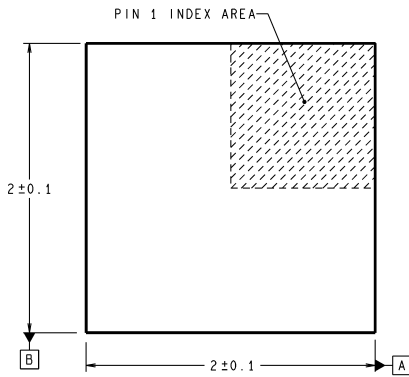

Order Number LM4915LQ
NS Package Number LQB08A

LIFE SUPPORT POLICY

NATIONAL'S PRODUCTS ARE NOT AUTHORIZED FOR USE AS CRITICAL COMPONENTS IN LIFE SUPPORT DEVICES OR SYSTEMS WITHOUT THE EXPRESS WRITTEN APPROVAL OF THE PRESIDENT AND GENERAL COUNSEL OF NATIONAL SEMICONDUCTOR CORPORATION. As used herein:

1. Life support devices or systems are devices or systems which, (a) are intended for surgical implant into the body, or (b) support or sustain life, and whose failure to perform when properly used in accordance with instructions for use provided in the labeling, can be reasonably expected to result in a significant injury to the user.
2. A critical component is any component of a life support device or system whose failure to perform can be reasonably expected to cause the failure of the life support device or system, or to affect its safety or effectiveness.



National Semiconductor
Americas Customer
Support Center
Email: new.feedback@nsc.com
Tel: 1-800-272-9959

National Semiconductor
Europe Customer Support Center
Fax: +49 (0) 180-530 85 86
Email: europe.support@nsc.com
Deutsch Tel: +49 (0) 69 9508 6208
English Tel: +44 (0) 870 24 0 2171
Français Tel: +33 (0) 1 41 91 8790

National Semiconductor
Asia Pacific Customer
Support Center
Email: ap.support@nsc.com

National Semiconductor
Japan Customer Support Center
Fax: 81-3-5639-7507
Email: jpn.feedback@nsc.com
Tel: 81-3-5639-7560

www.national.com